

NOTE: IN A BACK TO BACK INSTALLATION PROVIDE A MINIMUM OF 2 INCHES OF SPACING BETWEEN MODULES. A MINIMUM OF 3 FT IS REQUIRED IF A SECOND BASIN HEATER ELEMENT OPTION IS CHOSEN AND/OR ROUTINE ACCESS TO THE INSPECTION PORTS IS DESIRED.

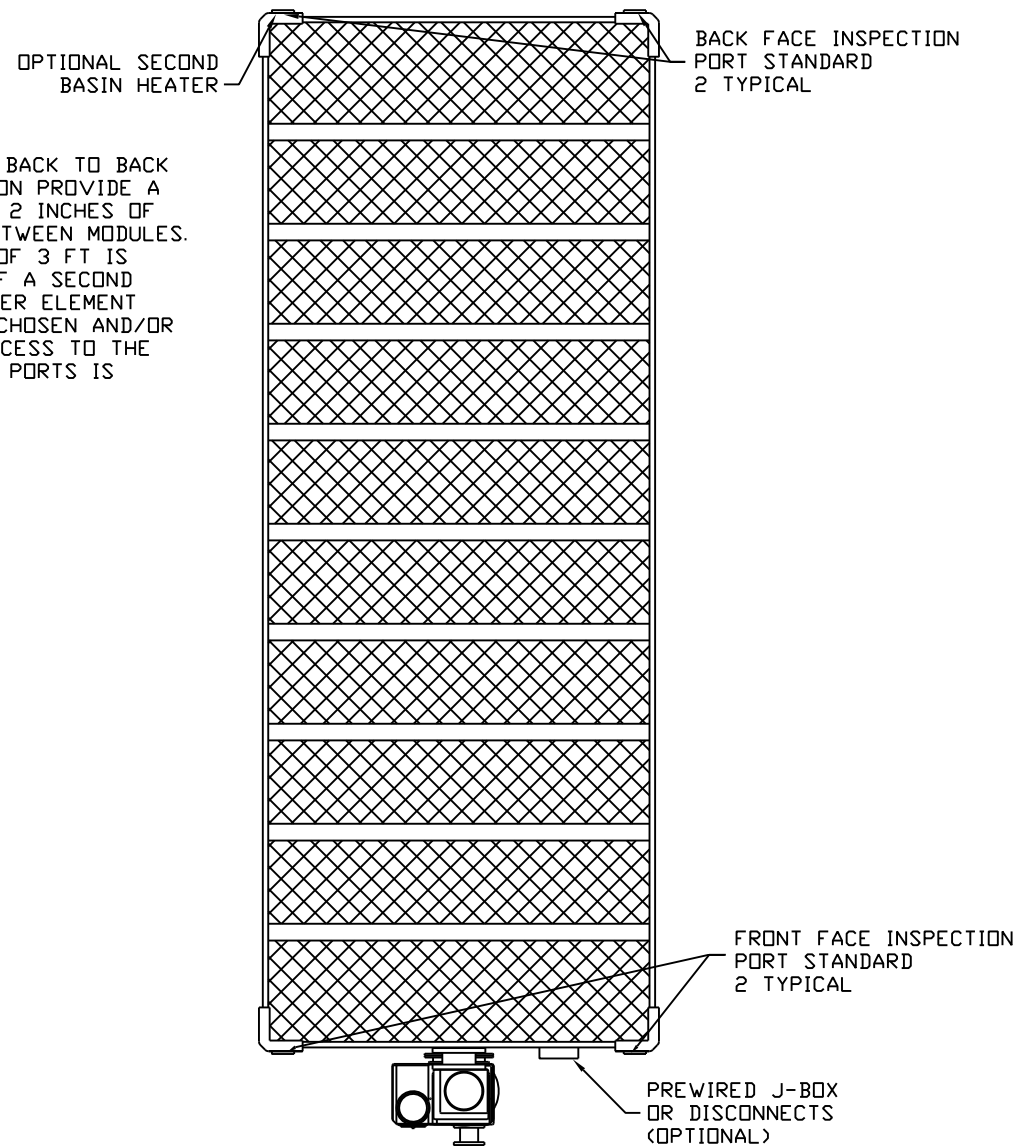

GENERAL INFORMATION:

BASIC DATA (PER CELL):

MIN/MAX GPM RANGE - 1,000/3,000
 ACTUAL DESIGN GPM -
 HWT(*F) -
 CWT(*F) -
 WBT(*F) -

MOTOR DATA (PER CELL):

BRAND - U.S. MOTORS (OR EQUIV)
 EFFICIENCY - HIGH
 HP - 5.0
 VOLTAGE - 460
 HZ - 60
 PHASE - 3
 NUMBER - 10

WEIGHTS (PER CELL):

DRY SHIPPING WEIGHT - 16,880 lbs
 OPERATING WEIGHT - 30,160 lbs

1. ALL EXTERNAL PIPING PROVIDED BY CUSTOMER.
2. EXTERNAL PIPING TO BE "STAND ALONE" (INDEPENDENTLY SUPPORTED).
3. NO LOAD TO BE APPLIED TO TOWER TECH TOWER OR SUMP.
4. FOR APPROPRIATE WATER LEVEL REFER TO STARTUP SECTION IN TOWER TECH'S DESIGN, INSTALLATION & OPERATION MANUAL.

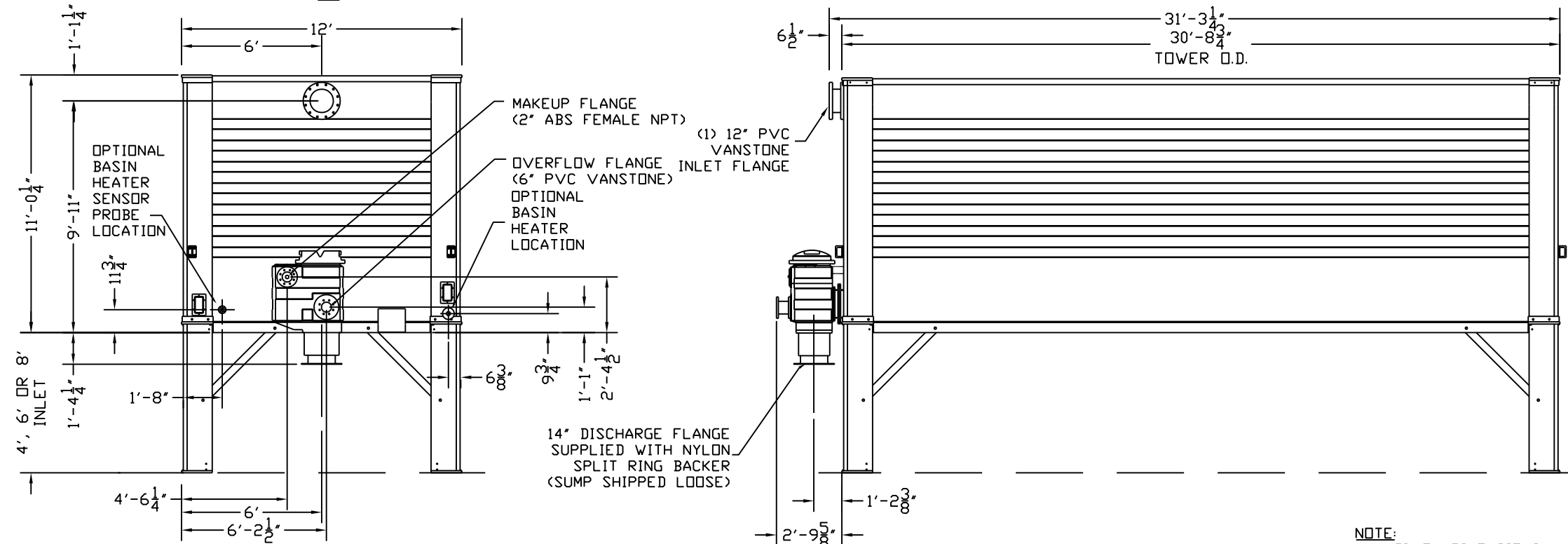

NOTE:
 ALL GIVEN DIMENSIONS
 ARE WITHIN ±1/2"

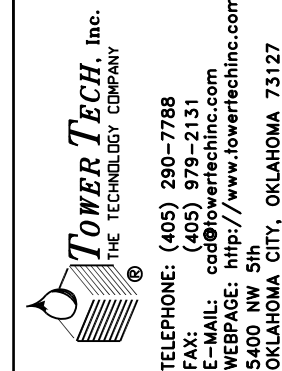

**Modular
 Fiberglass
 Cooling Tower**
 Model # TTXL-101950

© 2001-2008 BY TOWER TECH, INC.
 ALL RIGHTS RESERVED

TOWER TECH, INC.
1-Unit Installation
TTXL-10 Plan/Elevation

Oklahoma City, Oklahoma

FOR APPROVAL BY	DATE
Tower Tech Design Team	
REVISIONS	
NO.	DATE

DATE:	18 MAR 08
DRAWING#:	XL-10-2
PROJECT#:	LIBRARY
CUST PO#:	
DRAWN BY:	RFB
CHECKED BY:	
PLAN & ELEVATION	2