

GENERAL INFORMATION:

BASIC DATA (PER CELL):
 MIN/MAX GPM RANGE - 200/600
 ACTUAL DESIGN GPM - -
 HWT(°F) - -
 CWT(°F) - -
 WBT(°F) - -

MOTOR DATA:
 BRAND - U.S. MOTORS (OR EQUIV)
 EFFICIENCY - HIGH
 HP - 5.0
 VOLTAGE - 460
 HZ - 60
 PHASE - 3
 NUMBER - 2

WEIGHTS (PER CELL):
 DRY SHIPPING WEIGHT - 5,000 lbs
 OPERATING WEIGHT - 8,500 lbs

1. ALL EXTERNAL PIPING PROVIDED BY CUSTOMER.
2. EXTERNAL PIPING TO BE "STAND ALONE" (INDEPENDENTLY SUPPORTED).
3. NO LOAD TO BE APPLIED TO TOWER TECH TOWER OR SUMP.
4. FOR APPROPRIATE WATER LEVEL REFER TO STARTUP SECTION IN TOWER TECH'S DESIGN, INSTALLATION & OPERATION MANUAL.

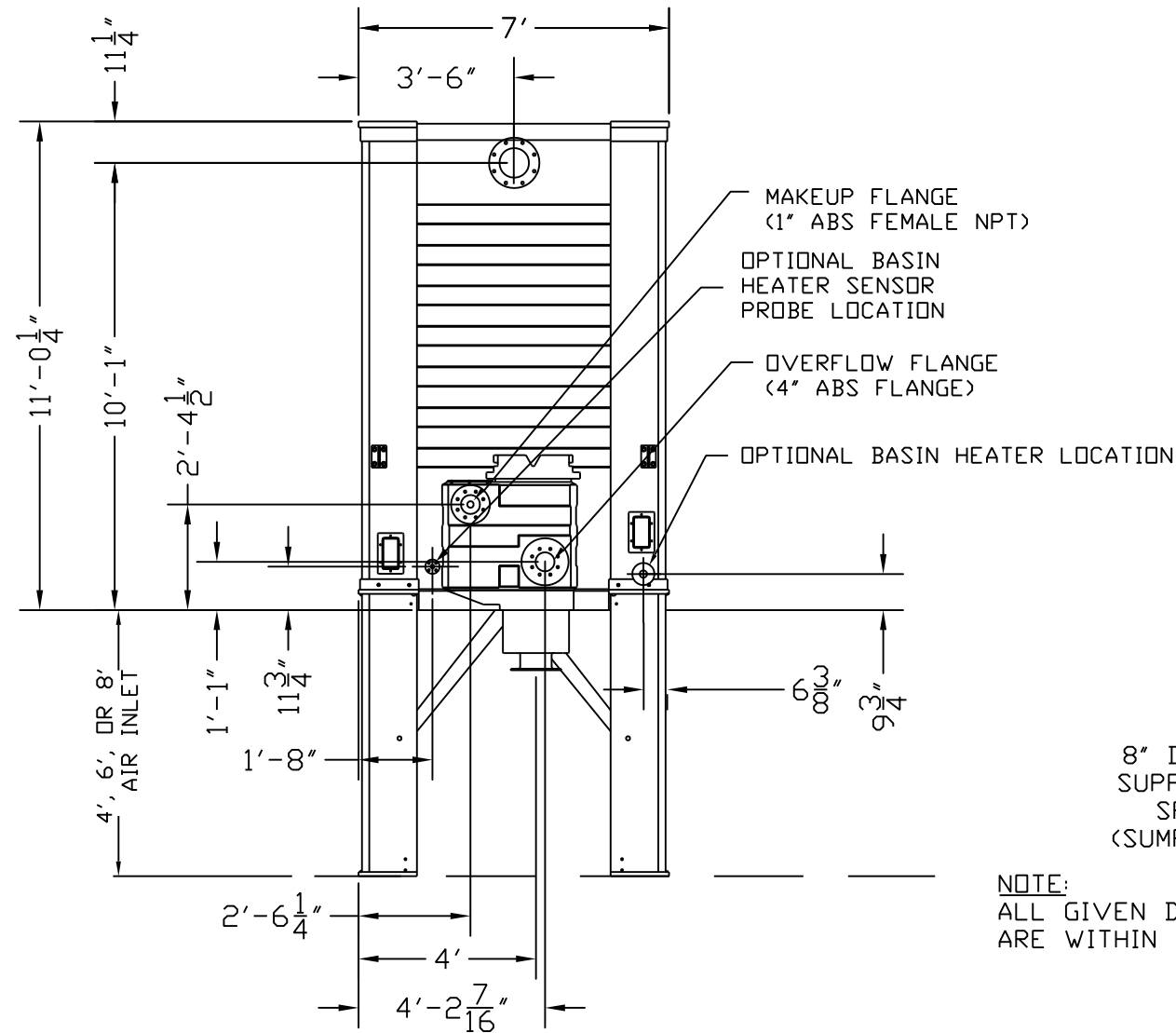

NOTE:
 ALL GIVEN DIMENSIONS ARE WITHIN ±1/2"

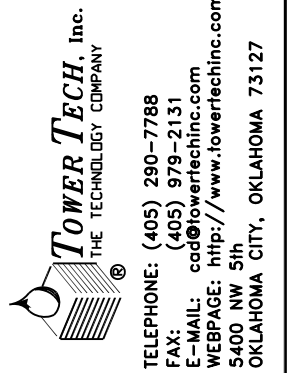
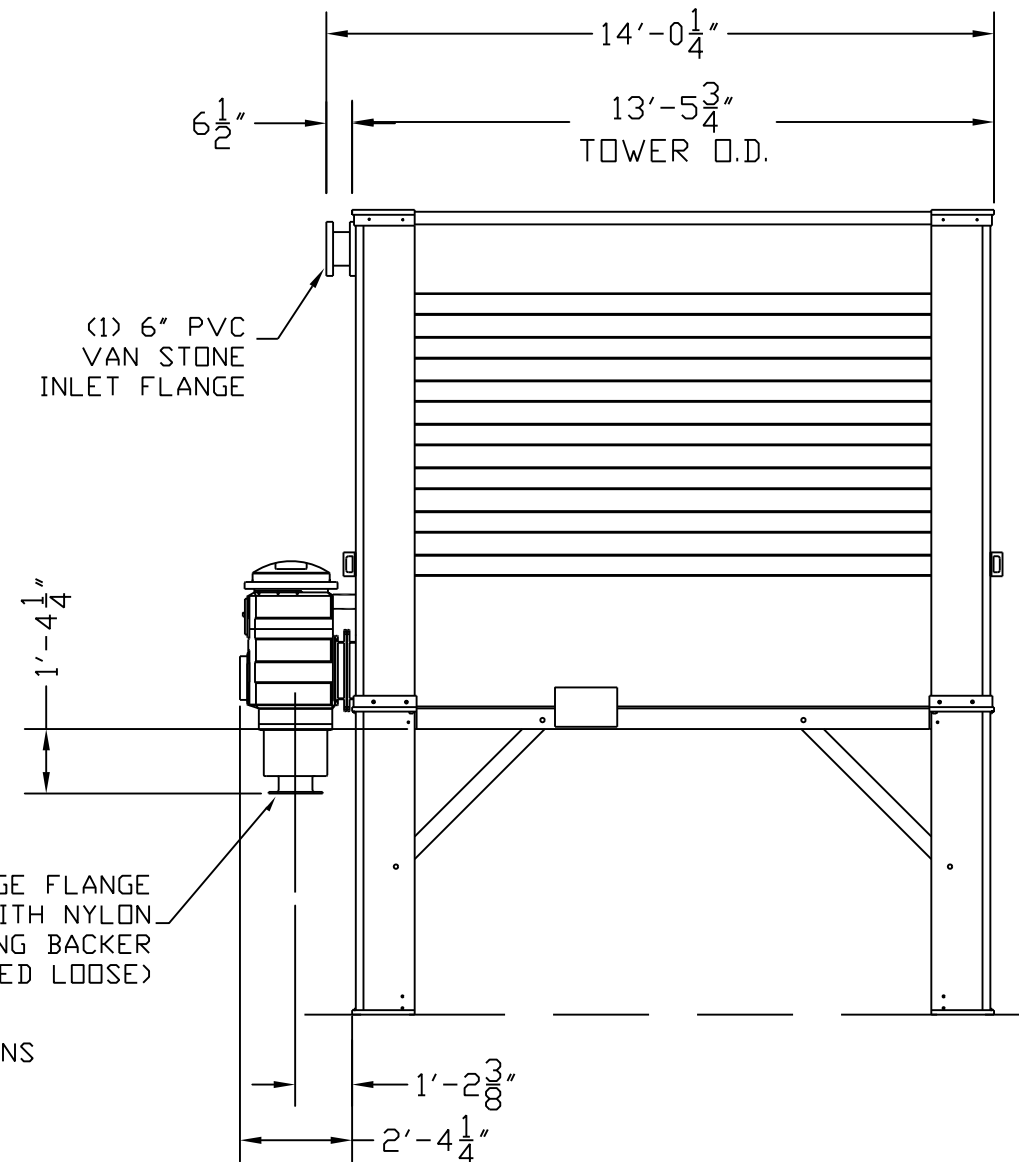

Modular
 Fiberglass
 Cooling Tower
 Model # TTXL-021950

© 2001-2008 BY TOWER TECH, INC.
 ALL RIGHTS RESERVED

TOWER TECH, INC.
1-Unit Installation
TTXL-02 Plan & Elevation

Oklahoma City, Oklahoma

FOR APPROVAL BY	DATE
Tower Tech Design Team	
REVISIONS	
NO.	DATE

DATE:	22 FEB 08
DRAWING#:	XL-02-2
PROJECT#:	LIBRARY
CUST PO#:	
DRAWN BY:	RFB
CHECKED BY:	
PLAN & ELEVATION	2